



Otto I

Dekorative Kugelleuchte für Lichtpunkthöhen von 3,00 m bis 5,00 m für Beleuchtungsaufgaben mit mittlerem Lichtbedarf

- Abdeckung in Kugelform aus opalem, schlagzähen PMMA
- Alle elektrischen Bauteile auf einem Elektrobloc
- Kugelaufnahme aus beständigem Polycarbonat, nur in schwarz, RAL 9005 (Tiefschwarz), lieferbar
- Sondermast mit Mastzopf \varnothing 60 mm für 1-armige Variante, Sondermast mit Mastzopf \varnothing 76 mm für 2-armige Variante (siehe S. 428 ff), bitte gesondert bestellen

Suitable for mounting heights from 3.00 metres to 5 metres for medium lighting requirements.

- Glazing: Globe made of opal PMMA
- One gear tray includes all electrical components
- Base made of UV-stabilised impact resistant polycarbonate, available in RAL 9005 (deep black) only
- Please order column with shaft \varnothing 60 mm for 1-arm version and column with shaft \varnothing 76 mm for 2-arm version separately (full range of columns see page 428 ff)

Boule décorative pour hauteurs de 3.00 m à 5.00 m pour éclairage de moyennes exigences

- Boule méthacrylate PMMA opale, résistant aux chocs
- Toutes les parties électriques assemblées en un seul bloc
- Embase en polycarbonate, livrable dans RAL 9005 seulement
- Mât spécial \varnothing 60 mm pour console simple et mât spécial \varnothing 76 mm pour console double (page 428 ff) à commander séparément

Spannung: 230V 50Hz
 Schutzart: IP 54
 Schutzklasse: II
 Hergestellt nach DIN VDE 0711
 Die Leuchten sind generell kompensiert.

Voltage: 230V 50Hz
 Other voltages on request
 Protection degree: IP 55
 Protection class: II
 Designed to DIN VDE 0711
 Luminaires generally compensated

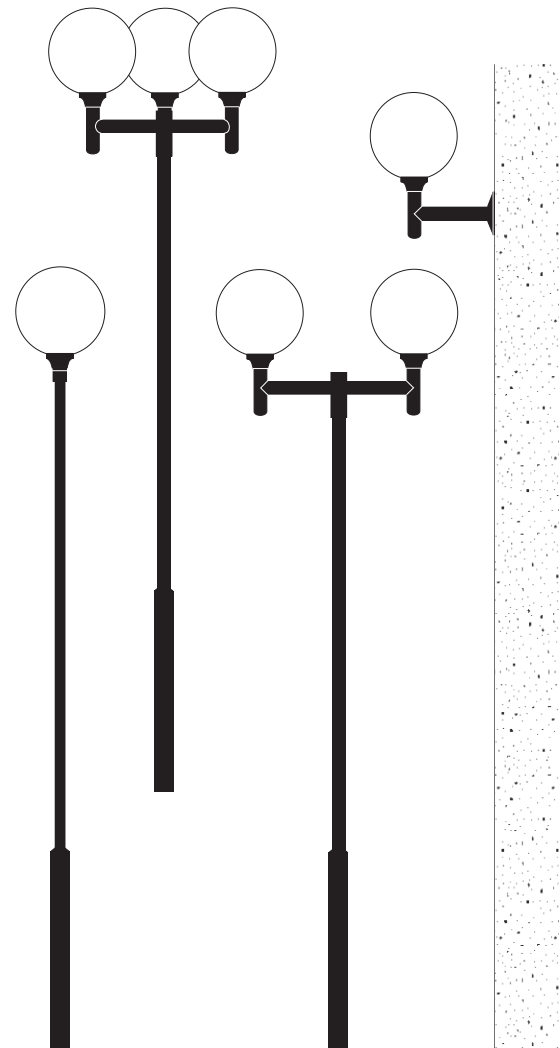

Tension: 230V 50Hz
 Indice de protection: IP 55
 Classe de protection: II
 Fabriqué selon norme DIN VDE 0711
 Luminaire compensé

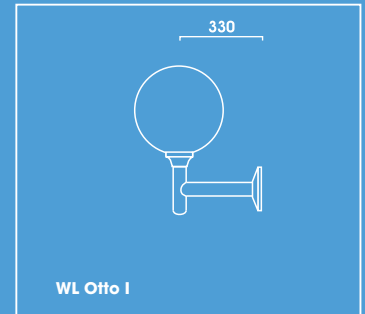
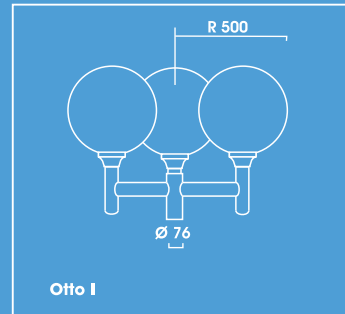
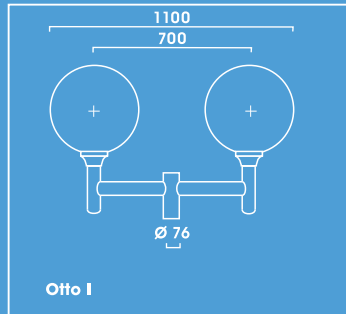
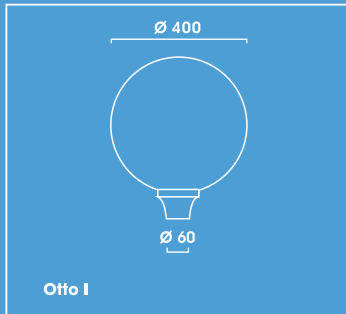

OTTO I



Otto I		Mastaufsatzleuchte, Abdeckung opal, Kugel Ø 400mm	
		<i>Post Top Luminaire, opal glazing, Globe Ø 400 mm</i>	
		<i>Luminaire En Top, vasque opale, Globe Ø 400 mm</i>	
	kg		N°
1-armig Single Arm Console Simple			
1 x HCl – E/P 70 W	4,1	E27	9.888.7032.00
1 x NAV – E 70 W	4,1	E27	9.888.2032.00
1 x NAV – E 50/70 W	4,2	E27	9.888.2152.00
1 x Dulux D/E 26 W	3,1	G24q-3	9.888.5497.00
1 x Dulux EL 23 W	2,9	E27	9.888.8780.00
2-armig Double Arm Console Double			
2 x HCl – E/P 70 W	14,2	E27	9.888.7032.20
2 x NAV – E 70 W	14,2	E27	9.888.2032.20
2 x NAV – E 50/70 W	14,4	E27	9.888.2152.20
2 x Dulux D/E 26 W	12,2	G24q-3	9.888.5497.20
2 x Dulux EL 23 W	11,8	E27	9.888.8780.20
3-armig 3 brackets Console Quadruple			
3 x HCl – E/P 70 W	19,2	E27	9.888.7032.30
3 x NAV – E 70 W	19,2	E27	9.888.2032.30
3 x NAV – E 50/70 W	19,4	E27	9.888.2152.30
3 x Dulux D/E 26 W	16,2	G24q-3	9.888.5497.30
3 x Dulux EL 23 W	15,6	E27	9.888.8780.30

WL Otto I		Wandleuchte, Abdeckung opal, Kugel Ø 400mm	
		<i>Wall Luminaire, opal glazing, Globe Ø 400 mm</i>	
		<i>Luminaire Mural, vasque opale, Globe Ø 400 mm</i>	
	kg		N°
1 x HCl – E/P 70 W	7,3	E27	9.813.7032.00
1 x NAV – E 70 W	7,3	E27	9.813.2032.00
1 x NAV – E 50/70 W	7,4	E27	9.813.2152.00
1 x Dulux D/E 26 W	6,3	G24q-3	9.813.5497.00
1 x Dulux EL 23 W	6,1	E27	9.813.8780.00