

Post top luminaire for traditional lamps and LED modules **HENNING I, HENNING II**

Installation:

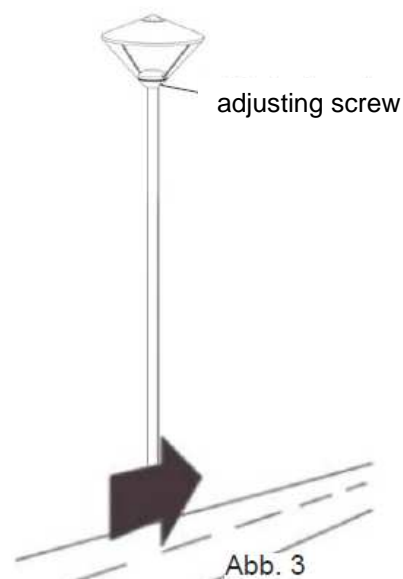
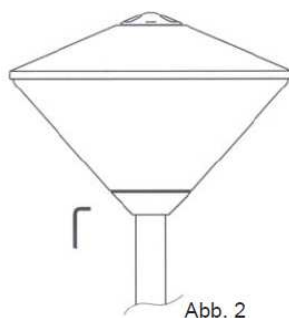
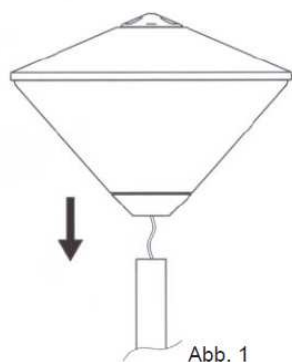

The luminaire is wired ready for connection. Shorten the attached cable according to the pole length. Feed the cable from top into the pole. Place the luminaire head vertically on the suitable pole (the luminaires are available with top entry \varnothing 60mm or \varnothing 76mm – expect for Henning II only for \varnothing 60mm). When installing an LED version of the named luminaires, turn the head until the adjustable screw of the base element shows in transverse direction of the road (see fig. 3). Tighten the adjustable screw with 10 Nm.

Change of the lamps/ LED modules:

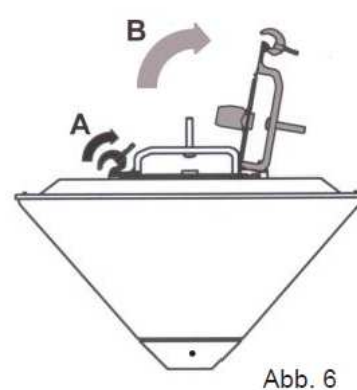
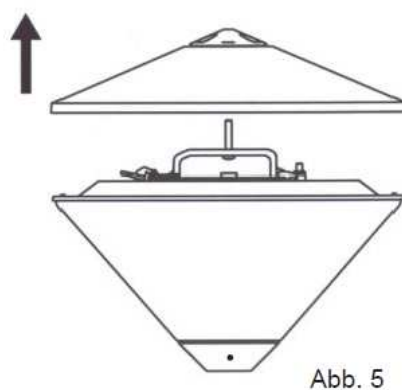
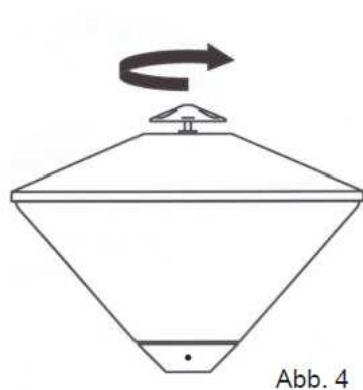

Change of the gear tray:

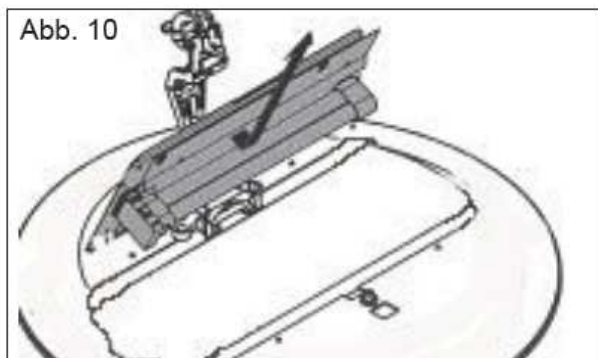
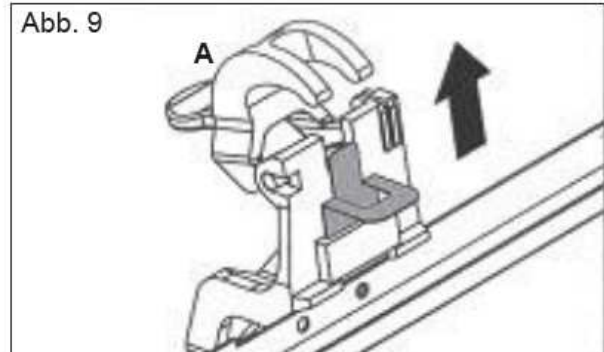
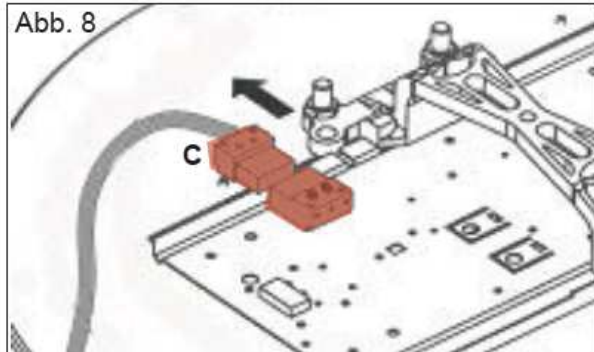

Disconnect the plug connector (C); fig. 8
 Pull the (A) backwards; fig.9.
 Pull the gear tray up and remove it; fig. 10,
 Insert the new gear tray and close it in reverse order.

This installation instruction is valid for the following luminaire heads:

